

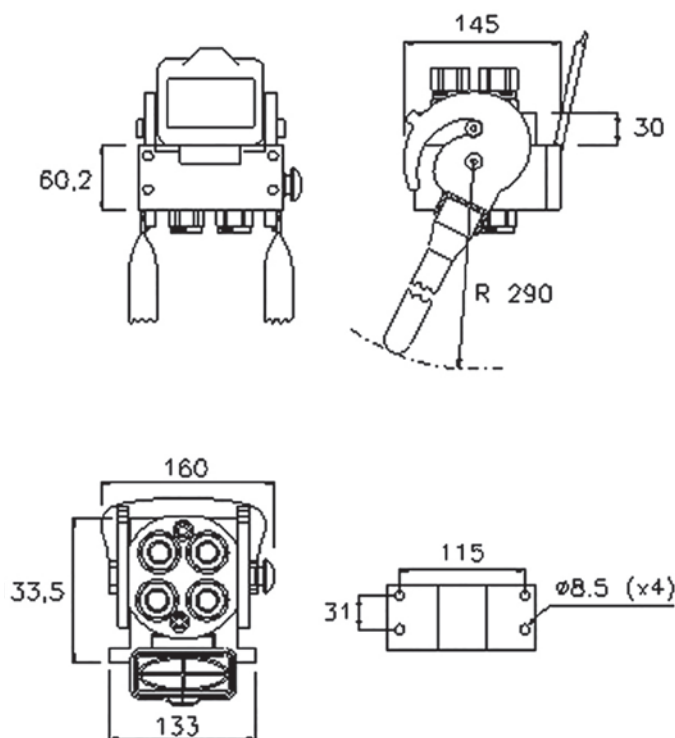

MF P508

MultiFaster 4 lines, size 08.

Applications



Technical Specifications

dash	Size		Working Pressure (MPa)	Flow Rate (l/min)	Spillage (ml)	Burst pressure (MPa)		
	mm	inch				Male	Female	Male + Female
08	12.5	1/2"	25	70	0.01	100	100	100

Material	Aluminium; Steel
Seals	NBR; PUR
Working temperatures	- 25 °C to + 100 °C
Surface treatment	MATE 500 (CrIII); Paint

Valve Type	Flat
Connection	Lever
Disconnection	Lever
Connection Under Pressure	Allowed Residual



P508

Size					Thread Type					FIXED
dash	mm	inch	Housing	Number of Couplings	Thread Type	Standard	Thread	Electrical Connector N	Connector Type	Part Number
04	6.3	1/4"	4	1	F BSPP	ISO 1179-1	BSPP 1/2" FEMALE			2P508-A-2-B F C
08	12.5	1/2"		1	F BSPP	ISO 1179-1	BSPP 1/4" FEMALE			
08	12.5	1/2"						1	7 PINS	
08	12.5	1/2"	4	4	F BSPP	ISO 1179-1	BSPP 1/2" FEMALE			2P508-4-F F C*
08	12.5	1/2"	4	4	O/ SAE	ISO 11926-1	1 - 1/16" - 12 UN FEMALE ORB			2P508-4-34S F C
08	12.5	1/2"	4	4	O3/ METRIC	ISO 8434-1-S	M24x1.5 MALE 16S			2P508-4-3/24F C
08	12.5	1/2"	4	4	O/ SAE	ISO 11926-1	3/4" - 16 UNF FEMALE ORB			2P508-4-12S F C
08	12.5	1/2"	4	4	F NPTF	ANSI B1.20.4	NPTF 1/2" FEMALE			2P508-4-12N F C
08	12.5	1/2"	4	3	O/ SAE	ISO 11926-1	3/4" - 16 UNF FEMALE ORB			2P508-3-12S F C
08	12.5	1/2"	4	2	F BSPP	ISO 1179-1	BSPP 1/2" FEMALE			2P508-2-2-12GFC
08	12.5	1/2"						2	3 PINS	
08	12.5	1/2"	4	3	F BSPP	ISO 1179-1	BSPP 1/2" FEMALE			2P508-1-3-12GFC
08	12.5	1/2"						1	3 PINS	
08	12.5	1/2"	4	3	F BSPP	ISO 1179-1	BSPP 1/2" FEMALE			3P508-3-12GFATC
08	12.5	1/2"	4	4	F BSPP	ISO 1179-1	BSPP 1/2" FEMALE			3P508-4-12G F C
08	12.5	1/2"	4	4	F BSPP	ISO 1179-1	BSPP 1/2" FEMALE			2P508-4-12G F C

* 1 coupling in stainless steel with seals in FKM. 3 couplings in steel with seals in NBR - PUR.

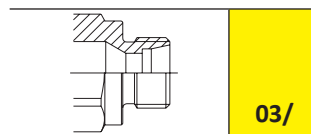
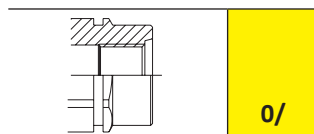
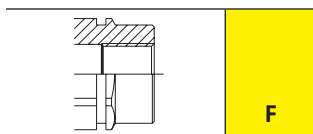

P508

Size					Thread Type					MOBILE
dash	mm	inch	Housing	Number of Couplings	Thread Type	Standard	Thread	Electrical N	Connector Type	Part Number
08	12.5	1/2"	4	4	71/ BSPP	JIS B 2351-1	BSPP 1/2 FEMALE ORB			3P508-4-71/12G M C
08	12.5	1/2"	4	4	F BSPP	ISO 1179-1	BSPP 1/2" FEMALE			3P508-4-F M C*
08	12.5	1/2"	4	4	03/ METRIC	ISO 8434-1-S	M24x1.5 MALE 16S			3P508-4-3/24M C
08	12.5	1/2"	4	4	0/ SAE	ISO 11926-1	3/4" - 16 UNF FEMALE ORB			3P508-4-12S M C
08	12.5	1/2"	4	3	F BSPP	ISO 1179-1	BSPP 1/2" FEMALE			3P508-3-12GMATC
08	12.5	1/2"	4	2	F BSPP	ISO 1179-1	BSPP 1/2" FEMALE			3P508-2-12G M C
08	12.5	1/2"	4	3	F BSPP	ISO 1179-1	BSPP 1/2" FEMALE			3P508-1-3-12GMC
08	12.5	1/2"						1	3 PINS	
08	12.5	1/2"	4	4	0/ SAE	ISO 11926-1	1 - 1/16" - 12 UN FEMALE ORB			2P508-4-34S M C
08	12.5	1/2"	4	4	03/ METRIC	ISO 8434-1-S	M24x1.5 MALE 16S			2P508-4-3/24M C
08	12.5	1/2"	4	4	0/ SAE	ISO 11926-1	3/4" - 16 UNF FEMALE ORB			2P508-4-12S M C
08	12.5	1/2"	4	4	F NPTF	ANSI B1.20.3	NPTF 1/2" FEMALE			2P508-4-12N M C
08	12.5	1/2"	4	3	0/ SAE	ISO 11926-1	3/4" - 16 UNF FEMALE ORB			2P508-3-12S M C
08	12.5	1/2"	4	2	0/ SAE	ISO 11926-1	3/4"-16 UNF FEMALE ORB			2P508-1-2-12SMC
08	12.5	1/2"						1	3 PINS	
08	12.5	1/2"	4	2	0/ SAE	ISO 11926-1	3/4"-16 UNF FEMALE ORB			2P508-1-2-12SFC
08	12.5	1/2"						1	3 PINS	
08	12.5	1/2"	4	2	F BSPP	ISO 1179-1	BSPP 1/2" FEMALE			2P508-1-2-12GMC
08	12.5	1/2"						1	3 PINS	
08	12.5	1/2"	4	2	F BSPP	ISO 1179-1	BSPP 1/2" FEMALE			3P508-2-12G MHY
08	12.5	1/2"	4	4	F BSPP	ISO 1179-1	BSPP 1/2" FEMALE			2P508-4-12G M C
08	12.5	1/2"	4	4	F BSPP	ISO 1179-1	BSPP 1/2" FEMALE			3P508-4-12G M C

* 1 coupling in stainless steel with seals in FKM. 3 couplings in steel with seals in NBR - PUR.

Spare Parts & Accessories

Female Half				Male Half					
Plates	Lever	Dust cover	Safety Lock	Plates	Seals male	Screws	Plugs	Guiding pins	Docking
KIT P508 F L	KIT LP508	KIT TA P5	KIT SP5 S	KIT P508 M	SK MF 12	KIT VP8	KIT TSP 38 M	KIT GP4	S P5

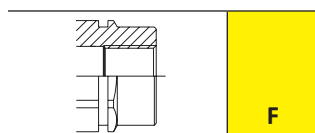

F

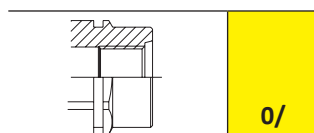

0/

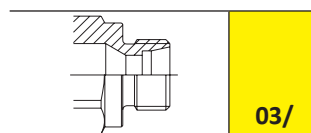

03/

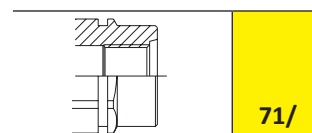

71/