

**PB 01008400179**



**PRESA DI FORZA A  
COMANDO PNEUMATICO  
PNEUMATIC CLUTCH  
POWER TAKE-OFF**

**CODICE PTO**  
PTO CODE

**010-081/082/  
083/084**

**CAMBIO**  
GEARBOX

**EATON/MERCEDES/  
ZF/VOLVO**

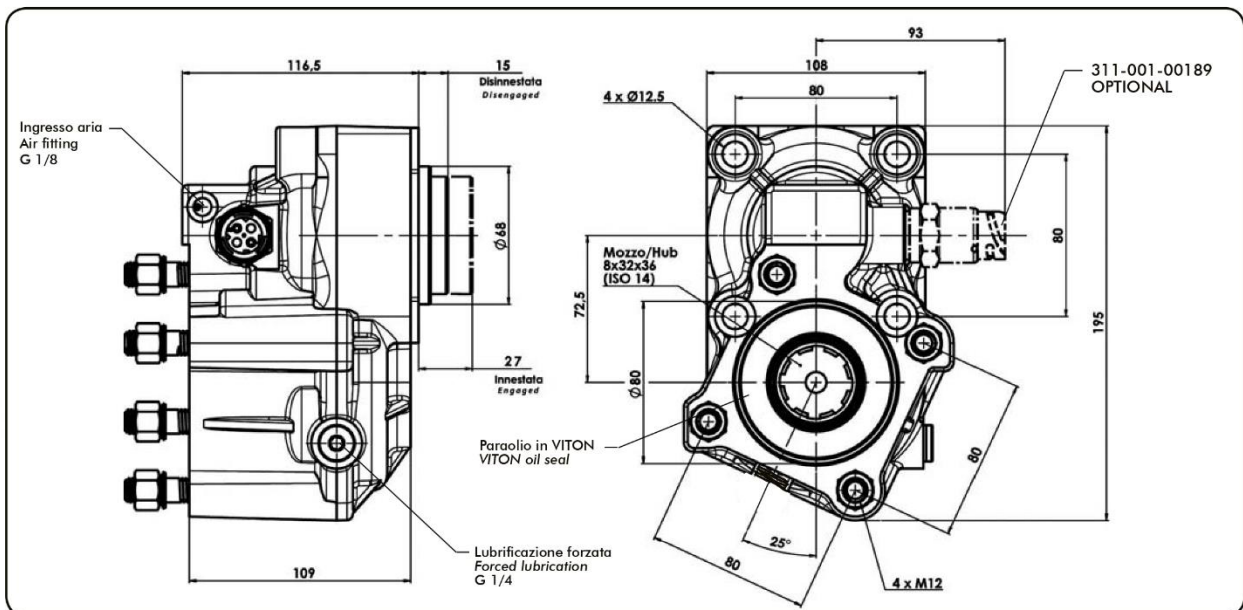
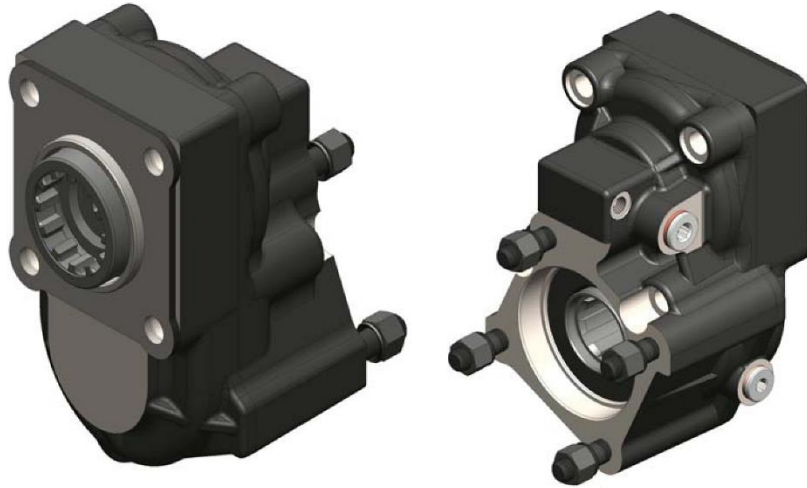

Codice PTO PTO code	Rapporto Ratio	Versione Version	Giri pto a 1000 giri motore Pto ratio@1000 eng.rpm	Coppia massima Max torque	Lato montaggio Mounting side	Rotazione Rotation	Peso Weight
<b>010-081-00172</b>	1:1,8	17	rpm	Nm	Posteriore Rear	Antior. Ccw	10,1
<b>010-082-00171</b>	1:1,53		350				
<b>010-083-00170</b>	1:1,33		400				
<b>010-084-00179</b>	1:1		450				
			Vedi indice See index	500			

**CONDIZIONI DI FUNZIONAMENTO / WORKING CONDITIONS**

I grafici, che indicano il prelievo di coppia in funzione del numero di giri, riguardano solamente la PTO. È necessario verificare il limite di prelievo di potenza dal cambio prima di effettuare l'applicazione.

The graphs indicating the allowed torque according to the RPM refers to the PTO only. It is necessary to check the torque limit of the gearbox before fitting the PTO.

**010-081-00172**

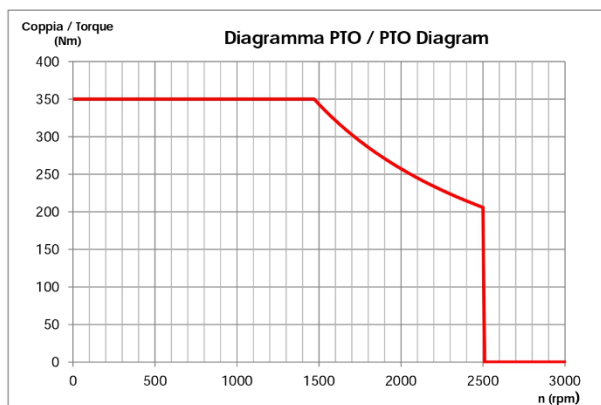

**010-082-00171**

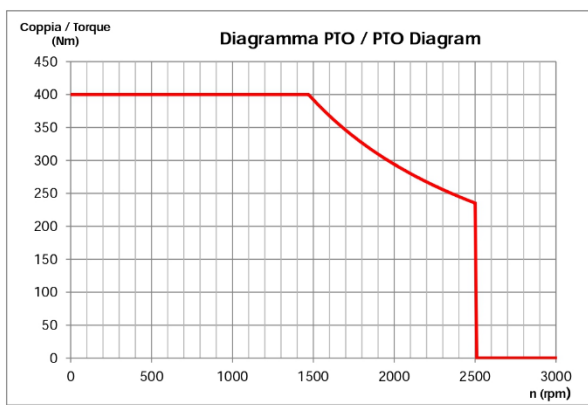

**010-083-00170**

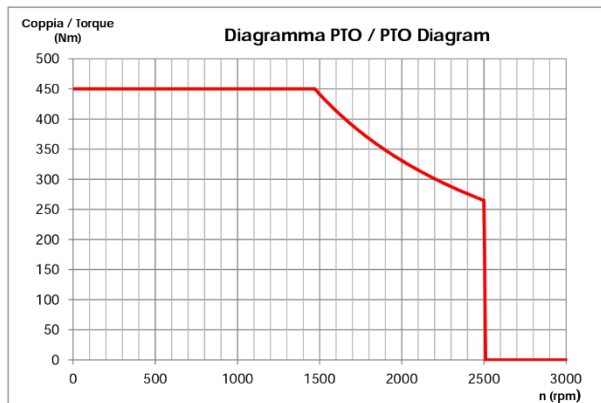

**010-084-00179**

