

TLine 85/18



(sidewalls 850 mm h x 180 mm w)

Mounting kit available:



Materials available:



Aluminium Painted Steel
RAL 7021

Stainless Steel**

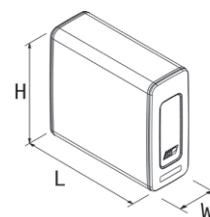

Products range	LT*	Features included	Filter Flange Code	Dimensions (only tank) L x H x W	Material	Product code NSOA = Aluminium NSOF = Painted Steel NSOI = Stainless steel**	Mounting kit code
TLine 85/18	150	- level gauge 127 mm with thermometer - 2 x suction connection 1"1/2 - return connection on sidewall 1"	135	1065x850x180	A / F / I**	-0150106PD00	mounting kit with shock absorber
	180	- return connection 1" on tank body available for additional breather vent installation - air breather cap h 69mm - breather vent***		1265x850x180		-0180126PD00	
	200	- 90°adjustable fitting for suction connection 1"1/2 - adjustable ball valve 1"1/2 - metal support plate for cable connectors		1415x850x180		-0200141PD00	included

* Full tank capacity ** Upon request *** Included in 180 and 200LT versions

TLine 85/15 SIDE MOUNTING

Mounting specifics

A (mm)	Level indicator capacity (l)
1065	135
1265	160
1415	180

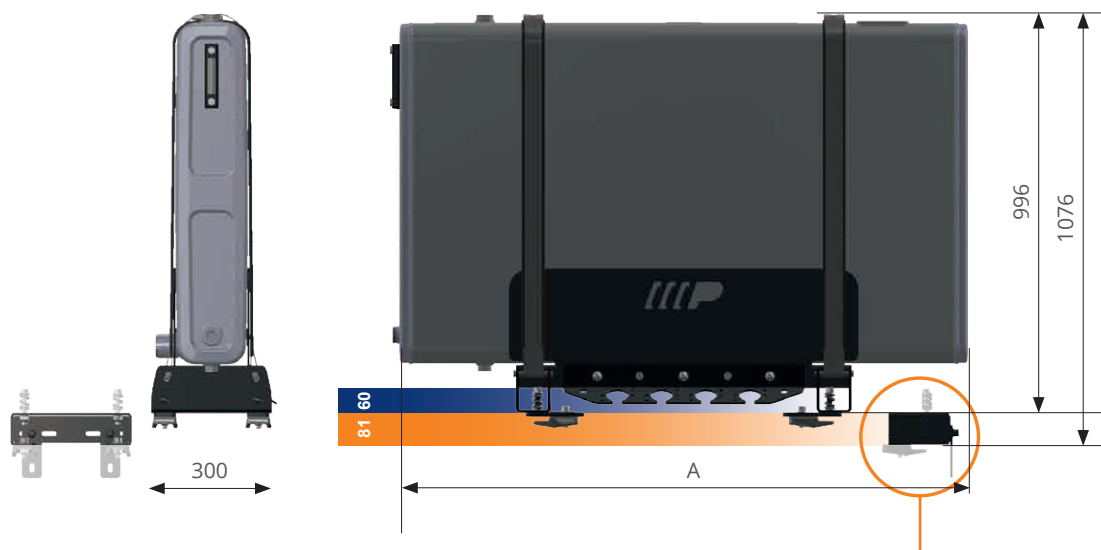

Spacer with multi-hole layout
 "AKMFRFT851800N0" available
 to increase the distance from the chassis.
 See accessories.



ACCESSORIES

Semi-immersed Return Filters



Filter Flange	l/min flow	Micron / μm	Inlet Connection	Product Code	Spare Parts Cartridge
135	250 l/min	40 μm microfibre	1"1/4	AFO0SEM136125CF	AFO0ELF205070CF
	200 l/min	21 μm microfibre	1"1/4	AFO0SEM136125F2	AFO0ELF205070F2
	150 l/min	10 μm paper	1"1/4	AFO0SEM136125C1	AFO0ELF205070C1

In-line filters



l/min flow	Micron / μm	Inlet connection	Product Code	Spare Parts Cartridge
150 l/min	25 μm microfibre	1"	AFO0LIN000100F2	AFO0ELF177096F2
230 l/min	60 μm wire mesh	1" 1/4	AFO0LIN000100RM	AFO0ELF177096RM
170 l/min	25 μm microfibre	1"	AFO0LIN000125F2	AFO0ELF177096F2
270 l/min	60 μm wire mesh	1" 1/4	AFO0LIN000125RM	AFO0ELF177096RM

Filter's clogging visual indicator



Products Range	Description	Specifics	Product Code	Spare Parts
Tline 85/18	Filter's clogging visual indicator	R 1/8" - EN 10226	AIIO0MPF195VSR42	/

Air breather caps



Products Range	Description	Specifics	Product Code	Spare Parts Cartridge
Tline 85/18	Air breather cap with air filter, fixing screws and anti-splash	h 69 mm - air cartridge paper 10 μm	ATPOPLSCAR0L110	AFAOCARCILT0P10

Breather vent



Products Range	Description	Specifics	Product Code	Spare Parts Cartridge
Tline 85/18	Breather vent 1"	air cartridge microfibre 3 μm	AFAOCARATT10000	/

ACCESSORIES

Level indicators

	Products Range	Description	Specifics	Product Code	Spare Parts
	Tline 85/18	sight level gauge	not graduated 127 mm distance between centers (M12) - with thermometer	AILOVISLIQ127T1	/

Adjustable ball valves

	Products Range	Description	Specifics	Product Code	Spare Parts
	Tline 85/18	adjustable ball valve MF with lever	1"1/2	ARU0ABV15000100	/

Pipe fittings

	Products Range	Description	Specifics	Product Code	Spare Parts
	Tline 85/18	straight pipe fitting, Ø51mm HOSE, inox band and sealing	1"1/2	ARA0PDNPGM15000	/
		90° adjustable pipe fitting, Ø51mm HOSE connection, inox band and sealing	1"1/2	ARA0PDNPGM15050	/

Adjustable fittings

	Products Range	Description	Specifics	Product Code	Spare Parts
	Oil tanks	90° adjustable fitting M/F	1"1/2	ARA0PDNFLT15050	/

Spacer with multi-hole layout (chassis adapter)

	Products Range	Description	Specifics	Product Code	Spare Parts
	Tline 85/18	Spacer with multi-hole layout	Painted steel spacer (81mm) to increase the distance from the chassis. Multiple hole layout for different positions.	AKMFRFT851800N0	/

Suzie plate

	Products Range	Description	Specifics	Product Code	Spare Parts
	Tline 85/18	Suzie plate	Upper suzie plate fixing kit for cables (holes to be drilled according to installation requirements)	AKM0SPC851800N0	/